



**Multi-Function Anemometer  
Operation Manual**

For product support, visit: [www.owon.com.hk/download](http://www.owon.com.hk/download)

July. 2023 Edition V1.0.1

Copyright © LILLIPUT Company. All rights reserved.

The LILLIPUT's products are under the protection of the patent rights, including ones which have already obtained the patent rights and those which are applied for. The information in this manual will replace all materials published.

The information in this manual was correct at the time of printing. However, LILLIPUT will continue to improve products and reserves the rights to change specification at any time without notice.

**owon**<sup>®</sup> is the registered trademark of the LILLIPUT Company.

**Fujian LILLIPUT Optoelectronics Technology Co., Ltd.**

No. 19, Heming Road

Lantian Industrial Zone, Zhangzhou 363005 P.R. China

**Tel:** +86-596-2130430

**Fax:** +86-596-2109272

**Web:** [www.owon.com.cn](http://www.owon.com.cn)

**E-mail:** [info@owon.com.cn](mailto:info@owon.com.cn)

# General Warranty

We warrant that the product will be free from defects in materials and workmanship for a period of 1 year from the date of purchase of the product by the original purchaser from our Company. This warranty only applies to the original purchaser and is not transferable to the third party, and does not apply to fuses, disposable batteries or to any product which has been misused, altered, neglected or damaged by accident or abnormal conditions of operation or handling.

If the product proves defective during the warranty period, we either will repair the defective product without charge for parts and labor, or will provide a replacement in exchange for the defective product. Parts, modules and replacement products used by our company for warranty work may be new or reconditioned like new performance. All replaced parts, modules and products become the property of our company.

In order to obtain service under this warranty, Customer must notify our company of the defect before the expiration of the warranty period. Customer shall be responsible for packaging and shipping the defective product to the service center designated by our company, and with a copy of customer proof of purchase.

This warranty shall not apply to any defect, failure or damage caused by improper use or improper or inadequate maintenance and care. We shall not be obligated to furnish service under this warranty a) to repair damage resulting from attempts by personnel other than our company representatives to install, repair or service the product; b) to repair damage resulting from improper use or connection to incompatible equipment; c) to repair any damage or malfunction caused by the use of not our supplies; or d) to service a product that has been modified or integrated with other products when the effect of such modification or integration increases the time or difficulty of servicing the product.

Please contact the nearest Sales and Service Offices for services.

**Excepting the after-sales services provided in this summary or the applicable warranty statements, we will not offer any guarantee for maintenance definitely declared or hinted, including but not limited to the implied guarantee for marketability and special-purpose acceptability. We should not take any responsibilities for any indirect, special or consequent damages.**

# Table of Contents

1. General Safety Requirement .....	1
2. Precautions .....	1
3. Main Features .....	2
4. Chart Instructions .....	2
Description of Measurement Icons .....	2
Beaufort Scale .....	2
5. Diagram of Quick Guide for Operation of Device .....	4
6. Product Introduction .....	5
Structure of Anemometer .....	5
Front Panel .....	5
Rear Panel .....	6
Button Area .....	7
Startup/ shutdown .....	8
Interface Setting of Anemometer .....	8
Measurement Mode Setting .....	9
Real-Time Measurement Mode .....	10
Statistics Mode .....	11
Chart Mode .....	11
View Storage Data .....	12
Data Storage Setting .....	13
Custom Mode Setting .....	13
Operation Time Setting .....	14
WiFi Connection .....	15
7. Technical Specifications .....	20

# 1.General Safety Requirement

Before use, please read the following safety precautions to avoid any possible bodily injury and to prevent this product or any other connected products from damage. In order to avoid any contingent danger, ensure this product is only used within the range specified.

Only the qualified technicians can implement the maintenance.

To avoid Fire or Personal Injury:

- **Do not operate without covers.** Do not operate the instrument with covers or panels removed.
- **Do not operate if in any doubt.** If you suspect damage occurs to the instrument, have it inspected by qualified service personnel before further operations.
- **In well-ventilated area.** Make sure the instrument installed with proper ventilation, refer to the user manual for more details.
- **Do not operate in wet conditions.**
- **Do not operate in an explosive atmosphere.**
- **Keep product surfaces clean and dry.**

## 2.Precautions

### Replacement of Impeller

- The wind impeller is vulnerable and shall be protected and replaced in time to void inaccurate measurement of data.
- Do not press the center of the impeller during its unloading or installation to prevent the accuracy of the spindle bearing from being affected(As shown Figure 2- 1).
- Press two sides of the impeller with two thumbs of both hands to remove the impeller.
- When inserting the new impeller, please keep the side with a small circle on the top front and upward during installation(As shown Figure 2- 2).
- Take waterproof, dustproof, anti-extrusion and anti-falling measures during use of the product.

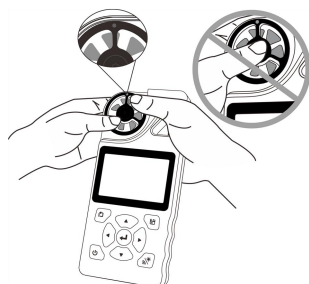

Figure 2- 1

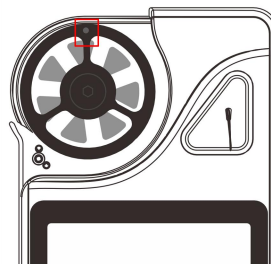









Figure 2- 2

### 3.Main Features

- It can measure wind speed, temperature, humidity, dew point, wet-bulb temperature, wind chill and air volume
- Two data storage modes: Manual storage and automatic record
- Unit conversion function
- The product is provided with dot matrix LCD screen for displaying more abundant contents
- Type-C lithium battery charging function
- Smart life APP remote real-time monitoring function
- USB data export analysis and real-time monitoring and recording functions

### 4.Chart Instructions

#### Description of Measurement Icons

Icon	Measurement Content
	Wind speed measurement (m/s)  ( km/s)   ft/s   kt (section)   mph (MPH)
	Temperature measurement °C   °F
	Humidity measurement %
	Dew point measurement °C   °F
	Wet bulb temperature measurement °C   °F
	Wind chill temperature measurement °C   °F
	Air volume measurement CMS (m3 /s)   CFS (cubic feet per second)

#### Beaufort Scale

Beaufort Scale	Name	Wind Speed (m/s)	Land Ground Symptom
0	Calm	0.0-0.2	Still, straight smoke
1	Light wind	0.3-1.5	Smoke shows the direction of the wind, and the weather vane does not move
2	Breeze	1.6-3.3	The breeze kisses the face; leaves rustle; the ordinary weather vane rotates
3	Gentle breeze	3.4-5.4	Leaves and twigs sway, and banners spread
4	Soft breeze	5.5-7.9	Dust flies, scraps of paper fly, little tree trunks sway
5	Fierce wind	8.0-10.7	Small trees with leaves sway, and there are wavelets on inland water

6	Strong wind	10.8-13.8	Big branches shake; power lines are whistling; and it is difficult to lift an umbrella
7	Moderate gale	13.9-17.1	The whole tree shakes, and there is resistance to walking into the wind
8	Gale	17.2-20.7	Twigs are broken and it is difficult to advance against the wind
9	Strong gale	20.8-24.4	Chimneys and houses will be blown out
10	Whole gale	24.5-28.4	It is not common on land; once it occurs, trees are pulled out, houses are blown down or damaged
11	Violent storm	28.5-32.6	It is rare on land; and once it occurs, it will be a major disaster
12	Hurricane	32.7-36.9	It barely occurs on land, once it occurs, it must cause massive casualties

## 5. Diagram of Quick Guide for Operation of Device

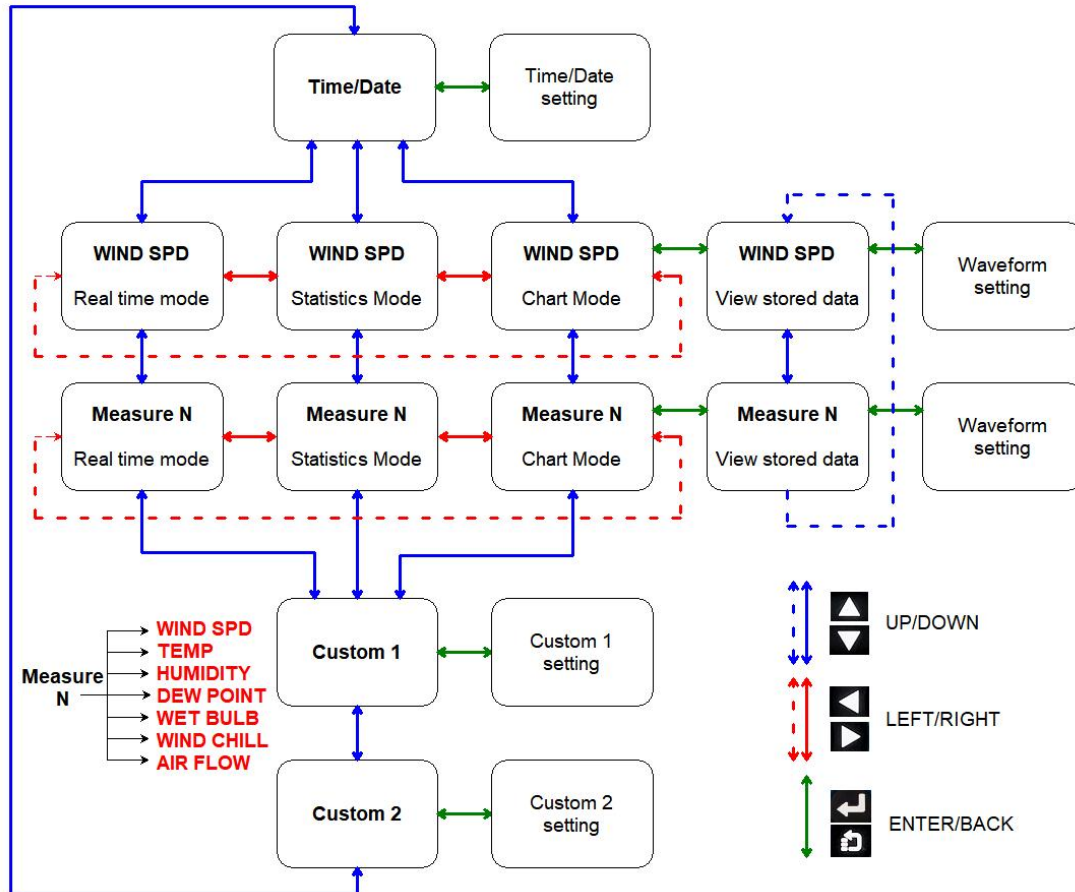



## 6. Product Introduction

The product is a portable multi-function anemometer and applicable for measuring wind speed, temperature, humidity, dew point, wet bulb temperature, wind chill and air volume.

### Structure of Anemometer

When you get a new anemometer, the first thing you need to know is the operation panel of anemometer. This chapter will provide a simple description and introduction to the operation and function of the front panel of anemometer so that you can be familiar with the use of the anemometer as soon as possible.

### Front Panel

The anemometer provides the user with a simple and clearly functional front panel for basic operations. There are nine buttons on the panel and you can access different functional menus or directly access specific functional applications through them.

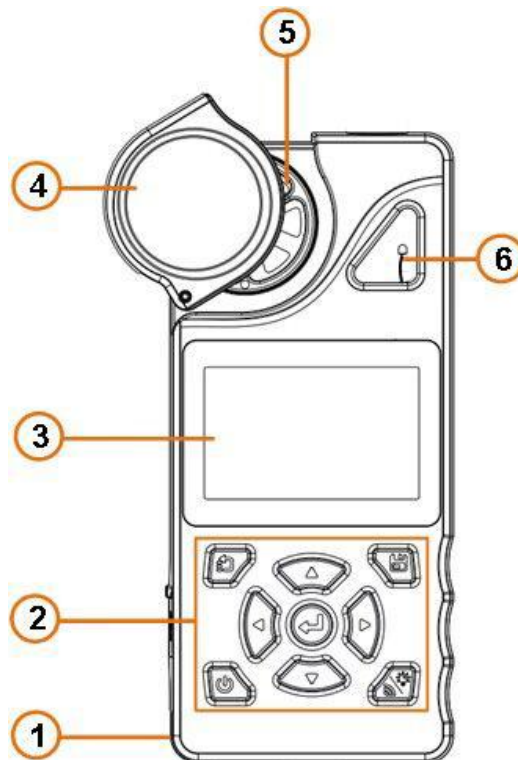

Figure 6- 1: Front Panel of Anemometer

1. Lanyard hole
2. Button area
3. LCD display area

4. Impeller hood
5. Impeller
6. Temperature sensor

## Rear Panel

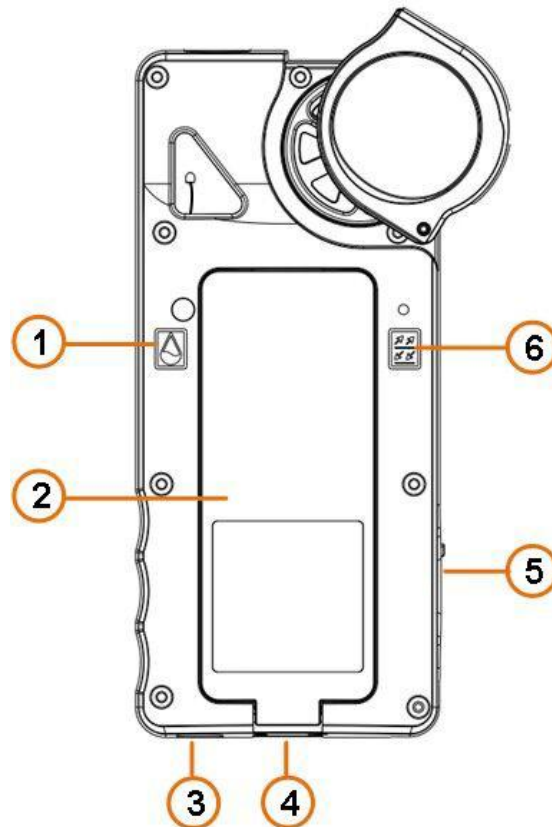

Figure 6-2: Rear View

1. Humidity sensor
2. Battery cover
3. Fixed hole
4. Switch buckle of battery cover
5. Type-C charge and communication port
6. Isobaric chamber

## Button Area

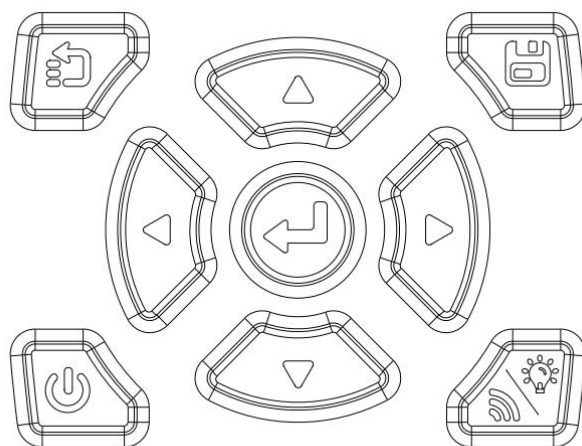



Figure 6-3: Description of Button Area



Button Icon	Button Name	Function Description
	Set button/ Return button	Press the button on the measurement interface to enter the setting interface; Press the button in the menu screen to return to the previous screen.
	Power button	Press and hold the button for 3 seconds to turn on or off the device. Charging status: The indicator is on Charge completed: The indicator is off Abnormal charging: The indicator flashes
	Backlight button/ Network connection	Short press: Press the button to turn on / off backlight; Press and hold the button for 3 seconds to enter network connection mode
	Save Data	Used for manual and fast storage or view the recording progress.
	UP button	Scroll up the measurement interface or menu.
	DOWN button	Scroll down the measurement interface or menu.
	Left button	Scroll left options; adjust the value of menu or unit of measurement.
	Right button	Scroll right options; adjust the value of menu or unit of measurement.

	Enter button/ unit changeover	Select a menu option, go to its submenu or confirm the task; Press it on the home interface of the measurement mode to switch the measurement unit.
---	----------------------------------	--

### Setting Button Menu

Menu	Description
WiFi Reset	Reset Smart life APP WiFi
Log Clear	Clear record data
Log Num	Set groups of records in the range of 1~8000
Log Rate	Set the recording interval time according to the following parameters: 2s ,5s ,10s ,30s ,1min ,6min ,10min ,30min ,1h ,2h ,6h,12h
Auto Log	Set automatic recording switch: Enable/ Disable
Shutdown	Set the automatic shutdown time according to the following parameters: off,1 min,5 min,10 min,30 min and the instrument will shut down automatically according to the set parameter under the condition of inaction
About	Related information on anemometer

### Startup/ shutdown

- Press and hold  Power button in the shutdown mode to start up the instrument;
- Press and hold  Power button in the startup mode to shut down the instrument.

### Interface Setting of Anemometer



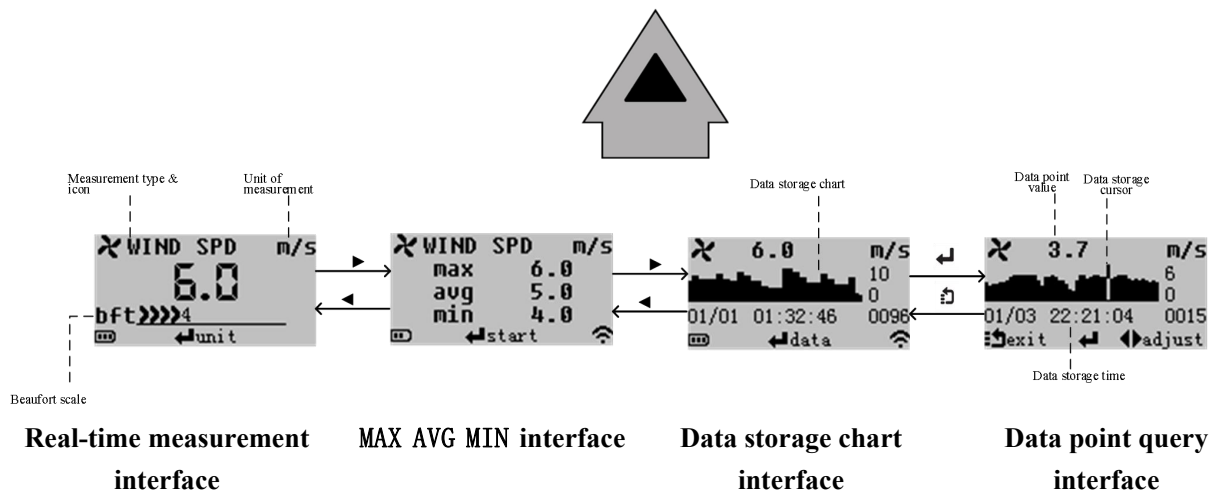

#### Other Measurements



Press  key to switch over unit of measurement

Press  key to enable/ disable statistics mode





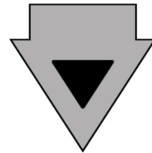

Press  key to enter the data source storage chart interface to view record data point

Press  or  key to enter or exit the data point view interface or press  or  key to view related data point value



### Other Measurements

Figur 6-4:Display Interface Description Diagram

- Press   Up /Down button for cycle switching: Date and time, wind speed, temperature, humidity, dew point, wet bulb temperature, wind chill, air volume, Custom 1 and Custom 2.
- Press   Left/ Right button for cycle switching: Real-time measurement, statistics mode and storage chart mode.
-  Return button: Used to return to functions or enter system setting mode.
-  Enter key: Used to enter the menu interface or for multi-functions.

## Measurement Mode Setting

The following operations are applicable for measurement of wind speed, temperature, humidity, dew point, wet bulb temperature, wind chill and air volume.

Take the wind speed measurement interface as an example, as follows:

## Real-Time Measurement Mode

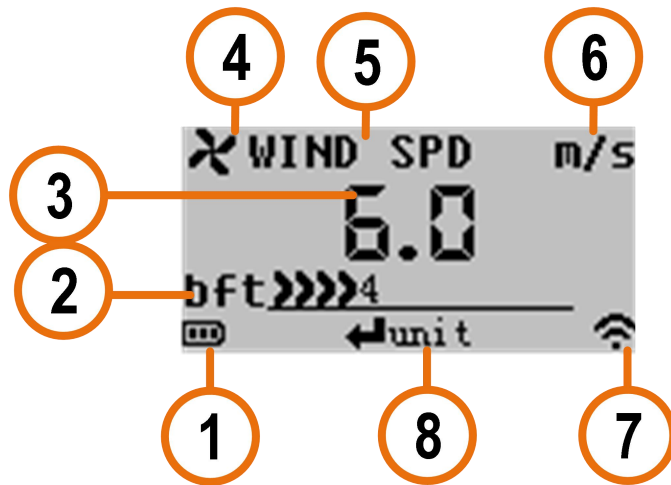

No.	Description
①	Battery level icon
②	Auxiliary information , for example, wind scale display
③	Real-time measurement
④	Measurement icon
⑤	Measurement name
⑥	Unit of measurement
⑦	Smart life APP connected icon
⑧	Button guide information
<b>Button Operation Instructions:</b>	
Press  key to switch over unit of measurement or for more settings;	
Press   button to switch measurement mode;	
Press   button to switch measurement type.	

## Statistics Mode

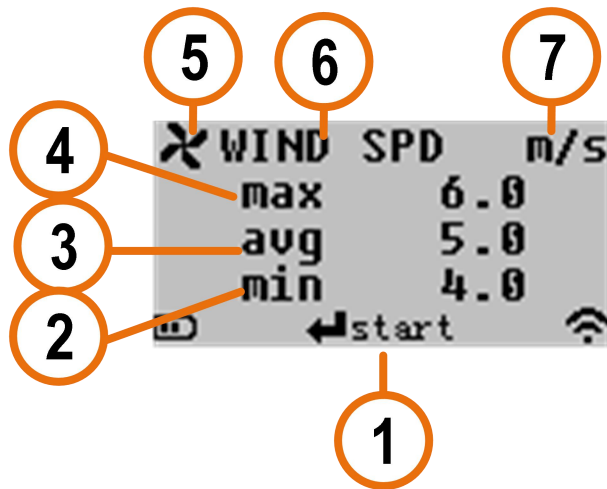





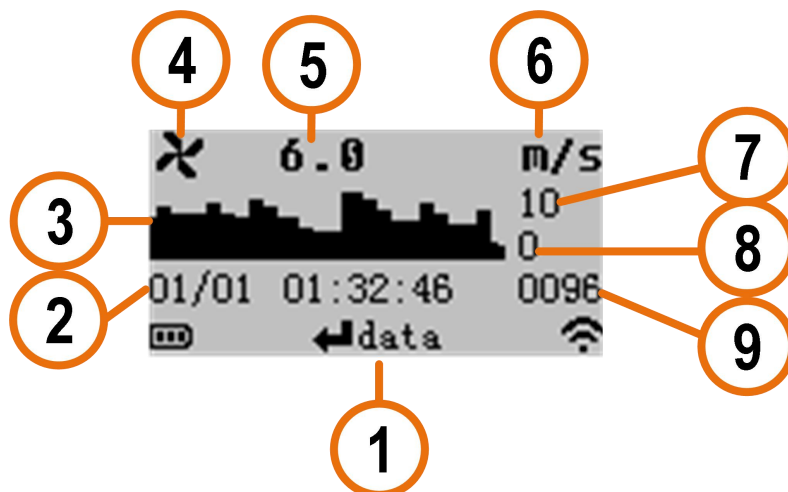

No.	Description
①	Button guide information
②	Minimum
③	Average
④	Maximum
⑤	Measurement icon
⑥	Measurement name
⑦	Unit of measurement

**Button Operation Instructions:**

- Press key to enable/ disable statistics mode;
- Press button to switch measurement mode;
- Press button to switch measurement type.

## Chart Mode



No.	Description
①	Button guide information
②	Storage time of last data
③	Measurement Data trend chart
④	Measurement icon
⑤	Real-time measurement
⑥	Unit of measurement
⑦	Upper limit of waveform displayed
⑧	Lower limit of waveform displayed
⑨	Groups of record data
<b>Button Operation Instructions:</b>	
Press  key to view storage data and set storage data;	
Press   button to switch measurement mode;	
Press   button to switch measurement type.	

### View Storage Data

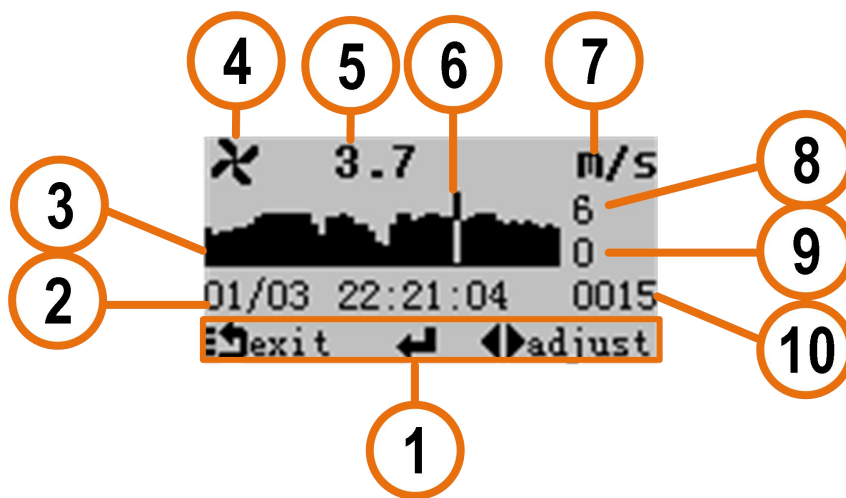





No.	Description
①	Button guide information
②	Data storage time at cursor
③	Measurement Data trend chart
④	Measurement icon
⑤	Storage measured value at cursor
⑥	Current data cursor
⑦	Unit of measurement
⑧	Upper limit of waveform displayed
⑨	Lower limit of waveform displayed
⑩	Groups of record data
<b>Button Operation Instructions:</b>	



Press  button to return to measurement mode;





Press  key to enter data storage setting interface;

Press   button to move current data cursor;

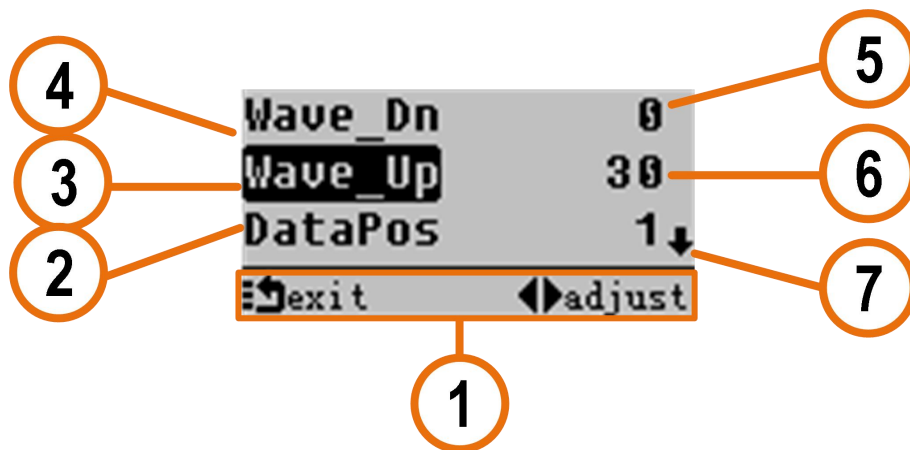
Press   button to switch measurement type.

## Data Storage Setting



No.	Description
①	Button guide information
②	Fast view specified data
③	Upper limit of waveform displayed & selected status of settings
④	Lower limit of waveform displayed
⑤	Set lower limit of waveform
⑥	Set upper limit of waveform
⑦	Lower guide mark
<b>Button Operation Instructions:</b>	
Press  button to return to measurement mode;	
Press   button to set the number of phase values;	
Press   button to switch measurement type.	

## Custom Mode Setting

This instrument can support two custom mode display interfaces and each interface can support up to three measurement types.

1. Press ▲ ▼ button to switch measurement mode to Custom Mode Interface 1 or Custom Mode Interface 2;



2. Press ↵ key to enter the setting interface of custom measurement mode.

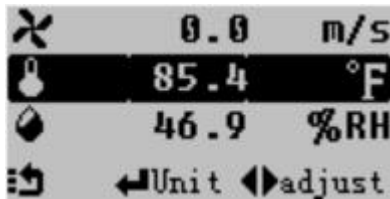

#### Button Operation Instructions:

Press ◀ ▶ button to switch measurement type;

Press ▲ ▼ button to scroll up/ down measurement type display;

Press ↵ key to switch over unit of measurement;

Press ↶ button to return to display interface of custom measurement mode.

## Operation Time Setting

1. Press ▲ ▼ button to switch measurement type to time display interface.



2. Press ↵ key to enter time settings interface.



#### Button Operation Instructions:

Press ◀ ▶ button to move the cursor to select the value to be selected;

Press ▲ ▼ to change the size of the value to be set;

Press ↻ button to return to time display interface.

## WiFi Connection

When a WiFi connection is required, please install the Smart Life 🏠 software on your mobile phone first. We can connect wirelessly via WiFi or a hotspot (Note: the WiFi module only supports 2.4G wireless channel).

When the anemometer is connected to the Smart Life software device for the first time or when the wireless network changes, the following connection steps shall be implemented:

1. Press and hold ↻ key to enter the setting interface, press ▲/ ▼ key to select WiFi Reset > > .

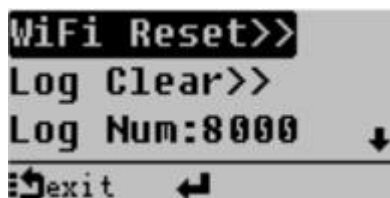

2. Press ↵ key to enter WiFi resetting interface.



3. The successful WiFi resetting interface pops up.



4. Press ↵ key to enter APP connection interface.



5. Open the Smart Life APP and click "Add Device" (Note: The wireless network & Bluetooth of the software device shall be enabled).

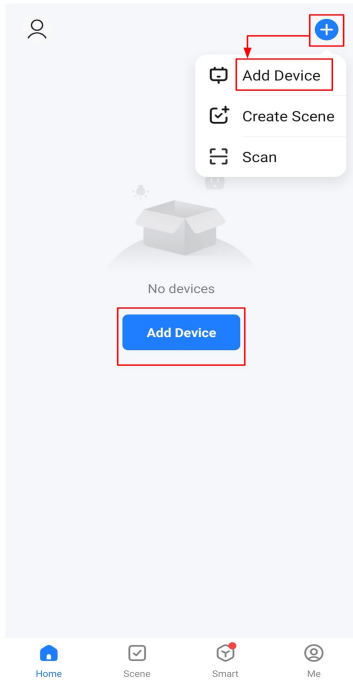

6. Click "Add" button.

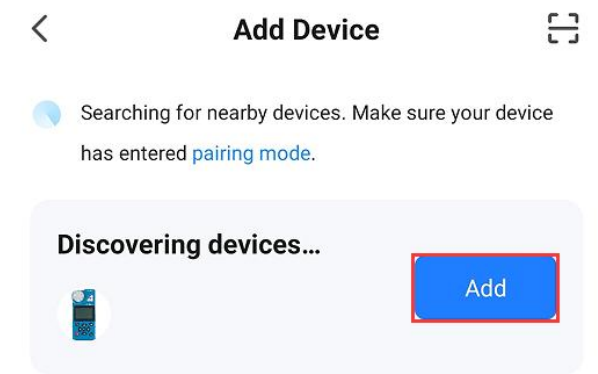

7. Enter the add device page,click"Add".

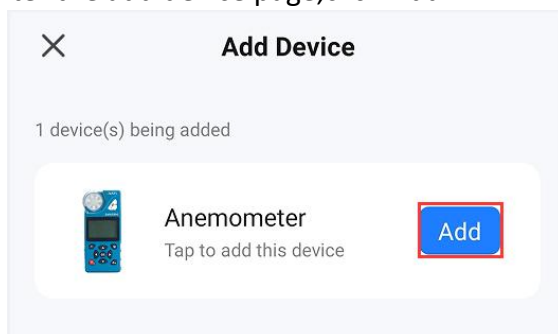

8. Select the WiFi or hotspot of the device and enter the password, then click "Next" button.

**Note:**

- Before selecting a hotspot, turn off the WiFi;
- When "WiFi connection prompt" appears on the connected hotspot, please click "Cancel" directly;

**The mobile phone is not connected to Wi-Fi.**

Only after your mobile phone is connected to Wi-Fi, can it be connected to the device.

Cancel

Go to Connect

- Enter the hotspot account and password when connecting to a hotspot.

×

**Enter Wi-Fi Information**

Choose Wi-Fi and enter password

WiFi

.....

Next

9. The device is being added.

×



**Add Device**

1 device(s) being added

Anemometer  
Being added

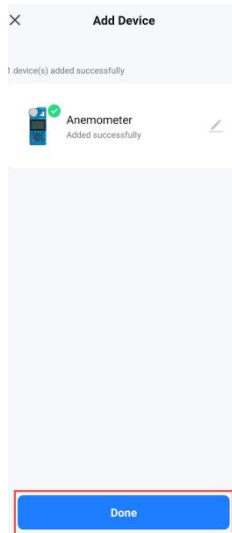
10. After adding the device successfully, click "Done" button.



11. The instrument shows the symbol "v" that the device has been added successfully. Then press  key to return the required interface (Note: Do not press  key, otherwise the connection will be interrupted).



12. When the device is added, enter the device control interface.









**Note:**

When the network is abnormal and disconnected, the following information will be displayed on the interface of the device and the Smart Life APP device. If the following situation occurs, please reconnect it according to the above steps.



When the routing and password of Smart Life APP device do not change, you can press and hold  button to directly connect the instrument with the Smart Life APP device.

## 7. Technical Specifications

Measurement Type	Icon	Name	Unit	Range	Resolution	Accuracy	Response Time
Wind speed		WIND SPD	m/s, km/h, ft/s, kt, mph	0.6~40 m/s	0.1m/s	±3%+0.1	0.5S
Temperature		TEMP	°C , °F	-10~50 °C	0.1°C	±1.0°C	0.5S
Humidity		HUMIDITY	%RH	5~95 %RH	0.1%RH	±5.0%RH	0.5S
Dew point		DEW POINT	°C , °F	-40~50°C	0.1°C	±2.0°C	0.5S
Wet bulb temperature		WET BULB	°C , °F	-40~50°C	0.1°C	±2.0°C	0.5S
Wind chill		WIND CHILL	°C , °F	-40~50°C	0.1°C	±2.0°C	0.5S
Air volume		AIR FLOW	CMS, CFS	0.001~300.0CMS	0.001CMS		0.5S
Dimensions	136.5 mm× 30 mm×64.5 mm (L*H*W)						
Weight	Approx. 0.2 kg						